

General Safety Information

WARNING

- Please use extra caution to keep your fingers away from the rotating disc brake rotor during installing or servicing the wheel. The rotor is sharp enough to inflict severe injury to your fingers if caught within the openings of moving rotor.
- Adjust the inner cable so that the protruding length is less than 20 mm (3/4 inch). If the protruding length is any longer, the end of the inner cable may become stuck in the rotor, which could cause the wheel to lock and the bicycle could fall forward causing serious injuries.
- The calipers and rotor will become hot when the brakes are operated, so do not touch them while riding or immediately after dismounting from the bicycle, otherwise you may get burned. Check that the brake components have cooled down sufficiently before attempting to adjust the brakes.
- Always make sure that the front and rear brakes are working correctly before you ride the bicycle.
- Before riding the bicycle, check that the pad thicknesses are 0.5 mm or more.
- Be careful not to allow any oil or grease to get onto the rotor and brake pads, otherwise the brakes may not work correctly.
- If any oil or grease do get on the pads, you should replace the pads. If any oil or grease gets on the rotor, you should clean the rotor. If this is not done, the brakes may not work correctly.
- Check the brake cable for rust and fraying, and replace the cable immediately if any such problems are found. If this is not done, the brakes may not work correctly.
- The required braking distance will be longer during wet weather. Reduce your speed and apply the brakes early and gently.
- If the road surface is wet, the tires will skid more easily. If the tires skid, you may fall off the bicycle. To avoid this, reduce your speed and apply the brakes early and gently.
- Check that the quick release lever is on the right side (the opposite side to the rotor). If the quick release lever is on the same side as the rotor, there is the danger that it may interfere with the rotor, so check that it does not interfere.
- It is important to completely understand the operation of your bicycle's brake system. Improper use of your bicycle's brake system may result in a loss of control or an accident, which could lead to severe injury. Because each bicycle may handle differently, be sure to learn the proper braking technique (including brake lever pressure and bicycle control characteristics) and operation of your bicycle. This can be done by consulting your professional bicycle dealer and the bicycle's owners manual, and by practicing your riding and braking technique.
- The M545 disc brakes are designed for optimum performance when used in combination with the BR-M545 (calipers), ST-M410 (brake lever), SM-RT61, SM-RT62 (rotor) and Shimano pad unit (M06). The brake lever used should be a two-finger lever for V-brakes, such as the ST-M410. If using in combination with 4-finger levers such as the BL-T400/ST-T400, the braking force will be higher. Accordingly, under some conditions such as certain riding positions or overall weight, the bicycle may fall over and injury may result if proper care is not taken.
- Obtain and read the service instructions carefully prior to installing the parts. Loose, worn, or damaged parts may cause injury to the rider. We strongly recommend only using genuine Shimano replacement parts. We strongly recommend that only genuine Shimano replacement parts be used.
- Read these Technical Service Instructions carefully, and keep them in a safe place for later reference.

CAUTION

- Disc brakes have a burn-in period, and the braking force will gradually increase as the burn-in period progresses. Make sure that you are aware of any such increases in braking force when using the brakes during the burn-in period. The same thing will happen when the brake pads or rotor are replaced.

Note

- If the brake caliper mounting boss and the dropout are not parallel, the rotor and caliper may touch.
- Parts are not guaranteed against natural wear or deterioration resulting from normal use.
- For maximum performance we highly recommend Shimano lubricants and maintenance products.

Technical Service Instructions

SI-8EB0A

Disc Brake System (For Cross-Country)

In order to realize the best performance, we recommend that the following combination be used.

Caliper	BR-M545
Brake Lever	ST-M410
Rotor	SM-RT61, SM-RT62
Brake pad unit (Metal Pads)	M06
Brake cable	

Installation

Wheel spoke lacing

Check that the spokes have been laced as shown in the illustration. A radial assembly cannot be used.

Lace the spokes as shown in Figure 1 below for the left side of the front wheel (the side where the rotor is installed), and the left and right sides of the rear wheel, and as shown in Figure 2 below for the right side of the front wheel.

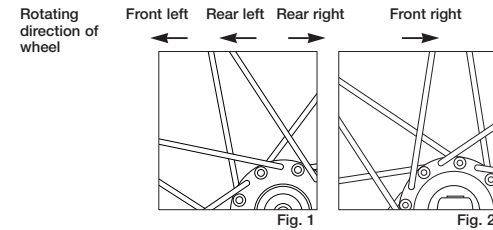

Installation of the rotor

<SM-RT61>

Install the rotor and the rotor tightening plate to the hub, and then install and tighten the bolts as shown in Fig. 1.

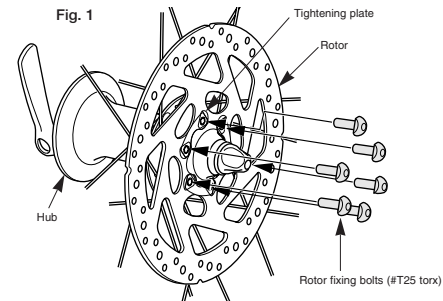

Tightening torque:
2 - 4 N·m {18 - 35 in. lbs.}

While wearing gloves, apply a force to the rotor to turn it in a clockwise direction as shown in Fig. 2. While doing this, tighten the rotor fixing bolts in the order shown in the illustration.

Use a flat-tipped screwdriver or similar tool to bend the edges of the tightening plate over the heads of the bolts as shown in Fig. 3.

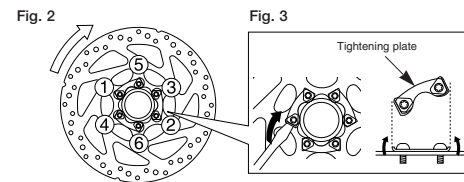

<SM-RT62>

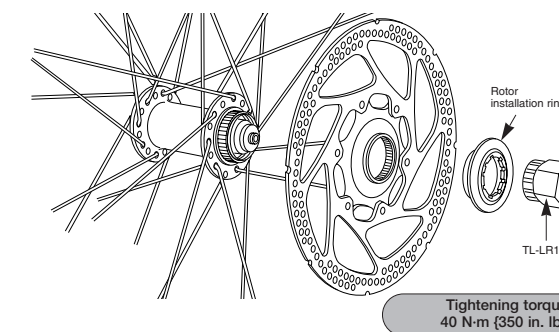

Tightening torque:
40 N·m {350 in. lbs.}

Installation of the brake lever

Use a 5 mm Allen key to install.

Use a handlebar grip with a maximum outer diameter of 32 mm.

Tightening torque:
6 - 8 N·m {53 - 69 in. lbs.}

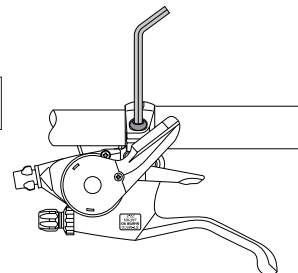

Installing the calipers

1. Install the bicycle wheel. Loosen the caliper fixing bolts, and then install the calipers to the frame so that the calipers work at the left and right.

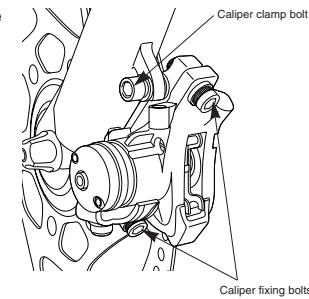

2. While wearing protective gloves, apply pressure to the adapter in the counterclockwise direction while tightening the caliper clamp bolt.

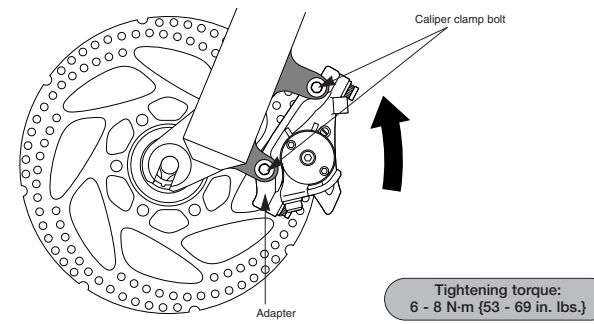

3. Securing the cable

Place the inner cable as shown in the illustration, and then tighten the cable fixing bolt.

Tightening torque:
6 - 8 N·m {53 - 69 in. lbs.}

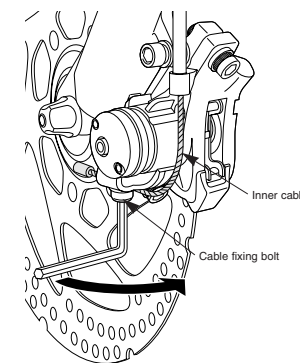

4. While depressing the brake lever, set the calipers to the required position and then tighten the caliper fixing bolts.

Tightening torque:
6 - 8 N·m {53 - 69 in. lbs.}

5. Loosen the pad adjustment screw by two clicks.

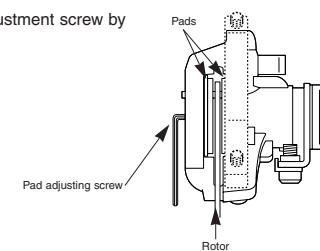

6. Depress the brake lever about 10 times until it touches the grip, and check that there are no problems with any components, and also that the rotors and the pads do not interfere with each other when the wheel is rotated.

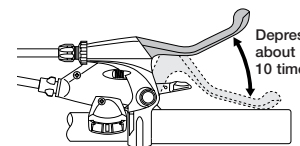

7. Turn the cable adjusting bolt to take up any slack in the cable.

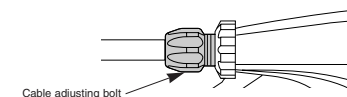

Secure the three bolts with a cap as shown in the illustration in order to prevent the bolts from coming loose.

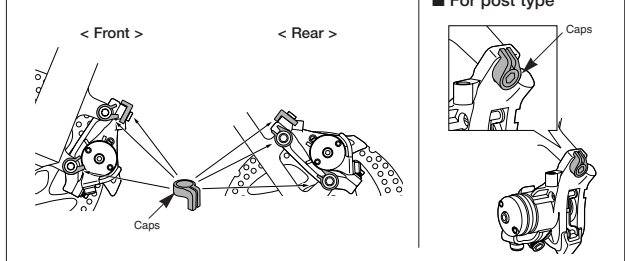

Adjusting when the pads are worn

Use a 3 mm Allen key to tighten the pad adjustment screw on the calipers so that clearances (A) and (B) are both 0.2 - 0.4 mm.

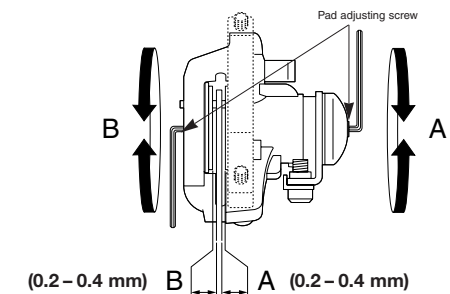

Replacing the brake pads

If the brake pads are worn down to a thickness of 0.5 mm, replace the brake pads.

1. Remove the bicycle wheel from the frame, and then remove the brake pads as shown in the illustration.

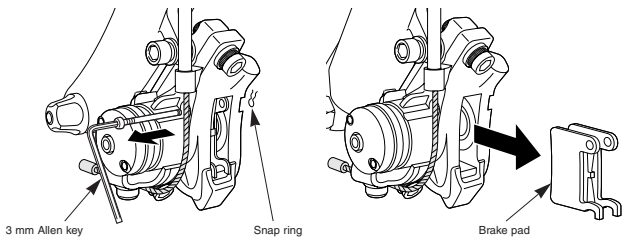

2. Loosen the pad adjusting screw and turn the cable adjusting bolts at the brake lever clockwise to loosen them.

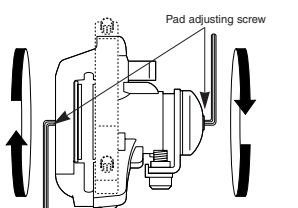

3. Install the new brake pads. Be careful not to forget to install the snap ring at this time.

Tightening torque:
2 - 4 N·m {18 - 35 in. lbs.}

Tighten the pad adjusting screw so that the clearance between the brake pad and the rotor is 0.2 - 0.4 mm.

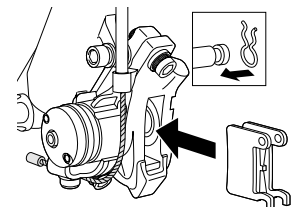

4. After checking that the brake pad and the rotor are not touching each other, check that there are no problems when the brake lever is depressed.

This service instruction explains how to use and maintain the Shimano bicycle parts which have been used on your new bicycle. For any questions regarding your bicycle or other matters which are not related to Shimano parts, please contact the place of purchase or the bicycle manufacturer.

SHIMANO

SHIMANO AMERICAN CORPORATION
One Holland, Irvine, California 92618, U.S.A. Phone: +1-949-951-5003

SHIMANO EUROPE B.V.
Industrieweg 24, 8071 CT Nunspeet, The Netherlands Phone: +31-341-272222

SHIMANO INC.
3-77 Oimatsu-cho Sakai-ku, Sakai, Osaka 590-8577, Japan

Please note: specifications are subject to change for improvement without notice. (English)
© Apr. 2006 by Shimano Inc. XBC SZK Printed in Malaysia.